



*"A Fine Tradition In Wood"*

# INTERIOR DOORS SECTION 3 INDEX

*hmillworks.com*  
1937 Troup Valley Road  
Mt. Pleasant Mills, PA 17853  
570-539-2611 ∴ 800-326-9873  
Fax 570-539-2379 ∴ 800-718-4463

<b><u>Product</u></b>	<b><u>Page</u></b>	<b><u>Effective Date</u></b>	<b><u>Revised Date</u></b>
<u>Pre-Hung Door Handing</u> . . . . .	3	Feb. 3, 2014	Dec. 27, 2013
<u>Pre-hung Adders</u> . . . . .	4	Feb. 6, 2017	Feb. 22, 2017
<u>Miscellaneous Pre-hung Option Adders</u> . . . . .	5	Feb. 6, 2017	Jan. 17, 2017
<u>Hollow Core Slabs</u> . . . . .	6	Feb. 6, 2017	Jan. 17, 2017
<u>Solid Core Slabs</u> . . . . .	7	Feb. 6, 2017	Jan. 17, 2017
<u>Hollow Core Bifolds</u> . . . . .	8	Feb. 6, 2017	Jan. 17, 2017
<u>Miscellaneous Slabs/Bifolds</u> . . . . .	9	Feb. 6, 2017	Jan. 17, 2017
<u>4 or 6 Panel Slabs/Bifolds</u> . . . . .	10	Feb. 6, 2017	Jan. 17, 2017
<u>True Divided 1, 9, or 15-Lite Slabs</u> . . . . .	11	Feb. 6, 2017	Jan. 17, 2017
<u>French Slabs</u> . . . . .	11	Feb. 6, 2017	Jan. 17, 2017
<u>Flush Slabs/Bifolds</u> . . . . .	12	Feb. 6, 2017	Jan. 17, 2017
<u>Louver/Louver Slabs/Bifolds</u> . . . . .	13	Feb. 6, 2017	Jan. 24, 2017
<u>Santa Rosa Slabs/Bifolds</u> . . . . .	13	Feb. 6, 2017	Jan. 17, 2017
<u>Mirror Bypass and Bifold Units</u> . . . . .	14	Feb. 6, 2017	Jan. 17, 2017
<u>Bifold Jamb Sets</u> . . . . .	14	Feb. 6, 2017	Feb. 22, 2017
<u>Miscellaneous Door Items</u> . . . . .	14	Feb. 6, 2017	Jan. 17, 2017
<u>Wood Lite Kits</u> . . . . .	15	Feb. 1, 2016	Jan. 15, 2016
<u>Louvers for Flush Slab Installation</u> . . . . .	15	Feb. 1, 2016	Jan. 15, 2016
<u>Interior Transom Units-Wood Grills&amp; Clip System</u> . . . . .	16	Feb. 6, 2017	Jan. 17, 2017
<u>Interior Transom Units-True Divided Lite</u> . . . . .	17	Feb. 6, 2017	Jan. 17, 2017

**Manufacturers we can supply:**

**Jeld-Wen Doors – [www.jeld-wen.com](http://www.jeld-wen.com)**  
**Stallion Door & Millwork - [www.stalliondoors.com](http://www.stalliondoors.com)**  
**Tru-Stile Doors, LLC - [www.trustile.com](http://www.trustile.com)**  
**Lemieux - [www.lemieuxdoors.com](http://www.lemieuxdoors.com)**  
**Madawaska - [www.madawaska-doors.com](http://www.madawaska-doors.com)**

**Timbergate – [www.berth.com](http://www.berth.com)**  
**Bollection - [www.bolectiondoor.com](http://www.bolectiondoor.com)**  
**Karona – [www.karonadoor.com](http://www.karonadoor.com)**  
**Supa – [www.supadoor.com](http://www.supadoor.com)**

Items that are on the above listed websites, but not on our price list, can be special ordered from the manufacturer. Please contact your Heister House sales representative for availability, pricing and to place your special order.

*All prices subject to change without notice.*



**Interior Doors**  
Section 3 – Page 2  
List Price  
Effective Date 2/1/16  
Revised Date 12/27/13

*This page intentionally left blank.*



## PRE-HUNG HANDING

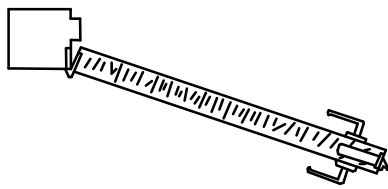

**RIGHT HAND (RHD)**

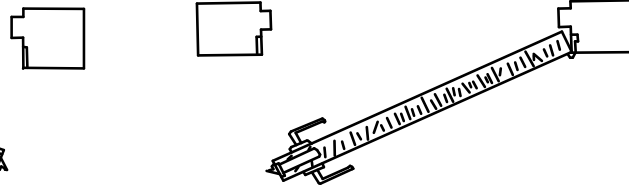

**LEFT HAND (LHD)**

Our door **handing** for pre-hung units is determined by pulling the door toward you. When ordering your pre-hung door, you should indicate which side the lockset bore will be on.

## DOUBLE PRE-HUNG HANDING

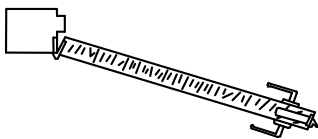

**RIGHT HAND ACTIVE (RHDA)**

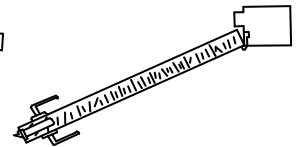
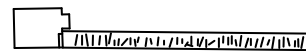
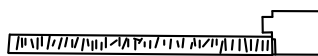

**LEFT HAND ACTIVE (LHDA)**

When ordering double pre-hung units with flush bolts and/or a t-astragal, indicate which **lockset** will be active. You do not need to indicate any handing when using ball catches.

## STANDARD BORE

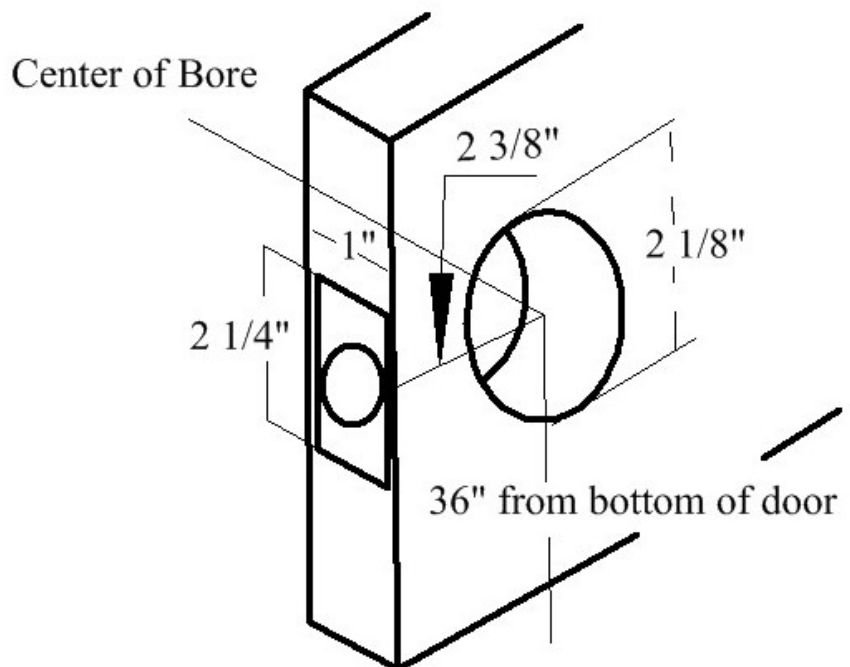



## DETERMINING PRE-HUNG UNIT LIST PRICES:

Heister House Millworks' standard pre-hung unit consists of jambs and HH936 Colonial door stop in the same species, 3 1/2"-5/8" radius corner bearing hinges and standard hinge and bore prep (see page 1 of this section). The following pages contain the slab list prices. To determine a pre-hung unit list price:

A.) When using a standard pre-hung unit as described above, use the set adder noted. You only need to add that number to your slab price to determine your pre-hung unit list price.

*Example: 6-panel pine 2/8 slab with 4 5/8" pine jambs, HH936 pine door stop, 3 1/2" x 5/8" radius corner light brass plain bearing hinges and standard prep and bore:*

B.) When other than standard unit materials are required: determine all adders from the following lists and add those to your required slab list price.

*Example: 4 panel solid core, primed 2/4 slab with 6 5/8" poplar jambs, HH936 poplar door stop, 3 1/2" x 5/8" radius corner dull chrome ball bearing hinges with standard prep and bore:*

See Builder's Hardware section for hinge, lockset, and other door hardware finish cross reference table.

All pre-hung units are produced per order to your specifications. Allow at least one week prep time and additional lead times as noted for non-stock slabs.

Prices reflected on these two pages reflect Pre-hung unit pricing only. For individual parts' list prices, see the respective section of our Product Catalog.

## PRE-HUNG ADDERS

### PRE-HUNG

STANDARD ADDER INCLUDES: *JAMBS, HH936 COLONIAL DOOR STOP, 3 1/2" X 5/8" RADIUS CORNER HINGES (3 PER SLAB), & STD. PREP & BORE*

JAMB OPTIONS	F/J	PINE	POPLAR	RED OAK
4 5/8" JAMBS AND COLONIAL DOOR STOP	S	S	S	S
6 5/8" JAMBS AND COLONIAL DOOR STOP	S	S	S	S
8 5/8" JAMBS AND COLONIAL DOOR STOP	N/A	S	S	S
9 1/4" JAMBS AND COLONIAL DOOR STOP	N/A	S	S	S
B-SPLIT 4 9/16" JAMBS W/ HH366 2 1/4" CASING	S	S	S	S
B-SPLIT 4 9/16" JAMBS W/ HH445 or HH446 3 1/4" CASING	* S	S	S	S
B-SPLIT 6 9/16" JAMBS W/ HH366 2 1/4" CASING	N/A	S	S	S
B-SPLIT 6 9/16" JAMBS W/ HH445 or HH446 3 1/4" CASING	N/A	S	S	S
2 1/4" HH366 CASING, MITERED AND SHIPPED LOOSE	S	S	S	S
3 1/4" HH445 or HH446 CASING, MITERED AND SHIPPED LOOSE	S	S	S	S
<b>DOUBLE PRE-HUNG</b>				
4 5/8" JAMBS AND COLONIAL DOOR STOP	S	S	S	S
6 5/8" JAMBS AND COLONIAL DOOR STOP	S	S	S	S
8 5/8" JAMBS AND COLONIAL DOOR STOP	S	S	S	S
9 1/4" JAMBS AND COLONIAL DOOR STOP	S	S	S	S
B-SPLIT 4 9/16" JAMBS W/ 2 1/4" HH366 CASING	S	S	S	S
B-SPLIT 4 9/16" JAMBS W/ HH445 or HH446 3 1/4" CASING	* S	S	S	S
B-SPLIT 6 9/16" JAMBS W/ 2 1/4" HH366 CASING	N/A	S	S	S
B-SPLIT 6 9/16" JAMBS W/ HH445 or HH446 3 1/4" CASING	N/A	S	S	S
2 1/4" HH366 CASING, MITERED AND SHIPPED LOOSE	S	S	S	S
3 1/4" HH445 or HH446 CASING, MITERED AND SHIPPED LOOSE	S	S	S	S
T-ASTRAGAL	N/A	S	S	S

\*Not available in HH446



Interior Doors  
 Section 3 – Page 5  
 List Price  
 Effective Date 2/6/17  
 Revised Date 1/17/17

## PRE-HUNG HINGE ADDERS (PER SLAB)

	BRIGHT BRASS	ANTIQU BRASS	SATIN NICKEL	ANTIQU NICKEL	COLONIAL BRONZE	BRIGHT CHROME	DULL CHROME
<b>PLAIN BEARING</b>							
3 ½” – 5/8” Radius Corner	S	S	S	S	S	S	S
3 ½” – ¼” Radius Corner	S	S	N/S	S	S	S	S
3 ½” – Square Corner	N/S	N/S	S	N/A	N/A	N/A	N/S
4” – 5/8” Radius Corner	N/S	S	S	S	N/A	call	S
4” – Square Corner	S	N/S	N/A	N/A	N/A	call	N/S
4 ½” – Square Corner	N/S	N/A	N/A	N/A	N/A	call	N/S
<b>BALL BEARING</b>							
3 ½” - 5/8” Radius Corner	S	S	S	N/S	S	S	S
3 ½” – Square Corner	S	N/A	N/A	N/A	N/A	N/A	N/S
4” – 5/8” Radius Corner	S	S	S	S	S	call	S
4” – Square Corner	N/S	N/A	N/A	N/A	N/A	N/A	N/S
4 ½” – Square Corner	N/S	N/A	N/A	N/A	N/A	call	N/S
<b>BOMMER HINGES, BALL CATCHES, &amp; FLUSH BOLTS</b>							
Bommer Spring Pivot Hinge	S	S	N/A	N/A	S	S	S
Ball Catch (per slab)	S	S	S	S	S	S	S
Flush Bolt	S	S	S	S	S	S	S

Double the hinge adder for double pre-hung units.

Hinge adders are for pre-hung units only.

## MISCELLANEOUS PRE-HUNG OPTION ADDERS

OPTION	ITEM #	PRICE
REDUCE HOLLOW CORE DOOR HEIGHT LESS THAN 1 1/2”	SD1	S
REDUCE HOLLOW CORE DOOR HEIGHT MORE THAN 1 1/2”	SD2	S
REDUCE SOLID CORE DOOR HEIGHT WITHOUT RE-BLOCKING	SD3	S
REDUCE SOLID CORE DOOR HEIGHT WITH RE-BLOCKING	SD4	S
REDUCE JAMB WIDTH	RIP	S
REDUCE WOOD PANEL DOOR HEIGHT ( <i>VOID WARRANTY, IF GREATER THAN 1”</i> )	RPDH	S
REDUCE DOOR WIDTH ( <i>VOID WARRANTY</i> )	RDW	S
HINGE AND BORE PREP ONLY	HBP	S
MORTISE LOCK PREP 1-5 SLABS	ML	S
MORTISE LOCK PREP 6 OR MORE SLABS	ML6	S
RED OAK SILL	S99	S
WEATHERSTRIP 3 SIDES AND KERF DOOR STOP	MDO10	S
WEATHERSTRIP 3 SIDES WITH 5 3/4” ALUMINUM SILL AND DOOR BOTTOM	MDO11	S
WEATHERSTRIP 3 SIDES WITH 5 3/4” BRONZE SILL AND DOOR BOTTOM	MDO11B	S
WEATHERSTRIP 3 SIDES WITH 7 1/4” ALUMINUM SILL AND DOOR BOTTOM	MDO12	S
WEATHERSTRIP 3 SIDES WITH 7 1/4” BRONZE SILL AND DOOR BOTTOM	MDO12B	S
WEATHERSTRIP 3 SIDES WITH WOOD SILL AND DOOR BOTTOM	MDO13	S
WEATHERSTRIP, PLANTATION PINE JAMBS ON 4 SIDES	MDO1466	S
WEATHERSTRIP, POPLAR JAMBS ON 4 SIDES	MDO1477	S
WEATHERSTRIP, RED OAK JAMBS ON 4 SIDES	MDO1499	S



## HOLLOW CORE SLABS

1 3/8" X 6/8, PRIMED, TEXTURED (TX) OR SMOOTH (SM)

	6-Panel		4-Panel		2-Panel						3-Panel
	Square Top Panel		Square Top Panel	Eyebrow Top Panel	Square Top Panel	Eyebrow Top Panel		Arch Top Panel	Square Top, Grooved Panels	Arch Top, Grooved Panels	Square Panel
	Colonist		Coventry	Provincial	Carrara	Camden	Princeton	Caiman	Corvado	Cashal	Avalon
Item #	C10--	C20--	C32--	J40--	C46--	C50--	C55--	C48--	C42--**	C52--	C57--**
Size	TX	SM	SM	TX	SM	TX	SM	SM	SM	SM	TX
1/0	S	S	N/S	N/A	N/S	N/S *	N/A	N/S *	N/A	N/S	N/S *
1/2	S	S	N/S	N/A	N/S	N/S *	N/A	N/S *	N/A	N/S	N/S *
1/3	S	S	N/S	N/A	N/S	N/S *	N/A	N/S *	N/A	N/S	N/S
1/4	S	S	N/S	N/S	N/S	N/S *	N/A	N/S *	N/A	N/S	N/S
1/6	S	S	S	S	S	S	S	S	N/S	S	N/S
1/8	S	S	S	N/A	N/S	N/S	N/S	N/S	N/S	N/S	N/S
1/10	S	S	N/S	N/S	N/S	N/S *	N/S	N/S *	N/S	N/S	N/S *
2/0	S	S	S	S	S	S	S	S	N/S	S	N/S
2/2	S	S	N/S	N/S	N/S	N/S	N/S	N/S	N/S	N/S	N/S
2/4	S	S	S	S	S	S	S	S	N/S	S	N/S
2/6	S	S	S	S	S	S	S	S	N/S	S	N/S
2/8	S	S	S	S	S	S	S	S	N/S	S	N/S
2/10	S	S	N/S	N/S	N/S	N/S	N/S	N/S	N/S	N/S	N/S
3/0	S	S	S	S	S	S	S	S	N/S	S	N/S

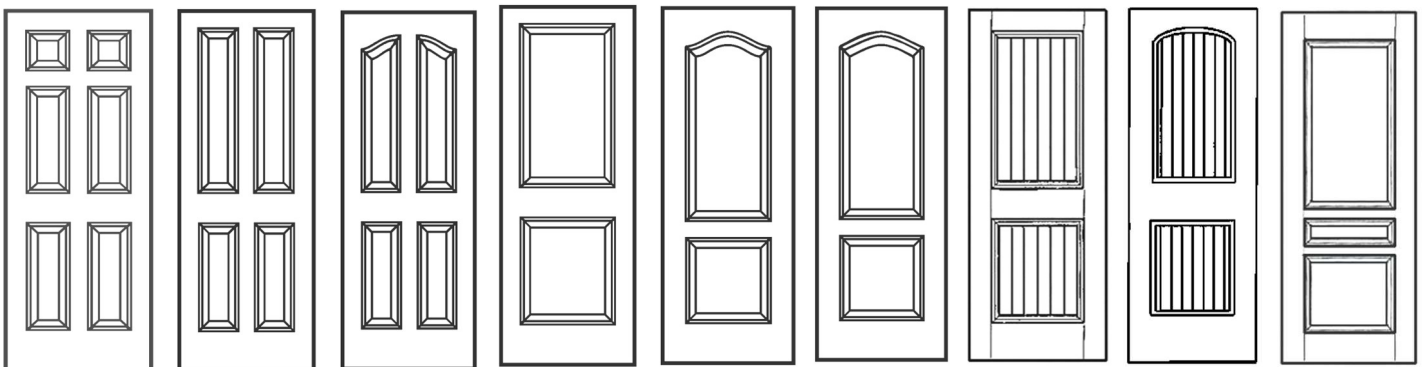

Colonist C10__ Smooth Colonist C20__	Smooth Coventry C32__	Provincial J40__	Carrara C46__	Camden C50__ Princeton C55__	Caiman C48__	Corvado C42__	Cashal C52__	Avalon C57__
--	-----------------------------	---------------------	------------------	---------------------------------------	-----------------	------------------	-----------------	-----------------

\*These slabs are too narrow to be bored for standard hardware.

\*\*The 2-panel, square top, grooved panels, and 3-panel doors can be purchased at same list as same size 6-panel slabs with a 2-4 week lead time.

Shaded list price indicates non-stock items. Please allow minimum one week lead time.



## SOLID CORE SLABS

1 3/8" X 6/8, PRIMED, TEXTURED (TX) OR SMOOTH (SM)

	6-Panel		4-Panel		2-Panel					3-Panel	
	Square Top Panel		Square Top Panel	Eyebrow Top Panel	Square Top Panel	Eyebrow Top Panel		Arch Top Panel	Square Top, Grooved Panels	Arch Top Panel, Grooved Panels	Square Panel
	Colonist		Coventry	Provincial	Carrara	Camden	Princeton	Caiman	Corvado	Cashal	Avalon
Item #	C14--	C24--	C34--	J44--	C47--	C54--	C56--	C49--	C43--**	C53--	C58--**
Size	TX	SM	SM	TX	SM	TX	SM	SM	SM	SM	TX
1/0	N/S	N/S	N/S	N/A	N/S	N/S *	N/S *	N/S *	N/A	N/S	N/A
1/2	N/S	N/S	N/S	N/A	N/S	N/S *	N/S *	N/S *	N/A	N/S	N/A
1/3	N/S	N/S	N/S	N/A	N/S	N/S *	N/S *	N/S *	N/A	N/S	N/S
1/4	N/S	N/S	N/S	N/S	N/S	N/S *	N/S	N/S	N/A	N/S	N/S
1/6	S	S	S	S	S	S	S	S	N/S	S	N/S
1/8	N/S	N/S	N/S	N/A	N/S	N/S	N/S *	N/S	N/S	N/S	N/S
1/10	N/S	N/S	N/S	N/S	N/S	N/S *	N/S *	N/S *	N/S	N/S	N/S *
2/0	S	S	S	S	S	S	S	S	N/S	S	N/S
2/2	N/S	N/S	N/S	N/S	N/S	N/S	N/S *	N/S	N/S	N/S	N/S
2/4	S	S	S	S	S	S	S	S	N/S	S	N/S
2/6	S	S	S	S	S	S	S	S	N/S	S	N/S
2/8	S	S	S	S	S	S	S	S	N/S	S	N/S
2/10	N/S	N/S	N/S	N/S	N/S	N/S	N/S	N/S	N/S	N/S	N/S
3/0	S	S	S	S	S	S	S	S	N/S	S	N/S

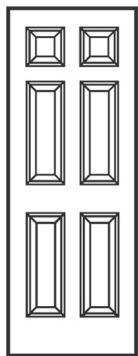

Colonist  
C14\_\_  
Smooth  
Colonist  
C24\_\_

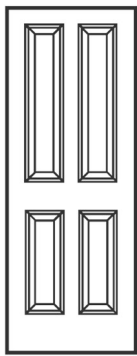

Smooth  
Coventry  
C34\_\_

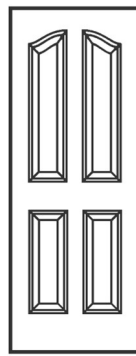

Provincial  
J44\_\_

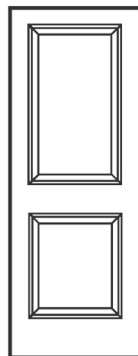

Carrara  
C47\_\_

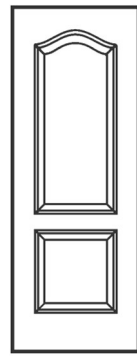

Camden  
C54\_\_  
Princeton  
C56\_\_

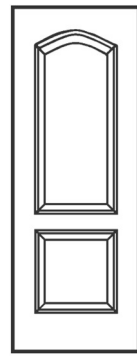

Caiman  
C49\_\_

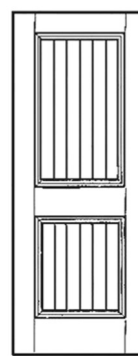

Corvado  
C43\_\_

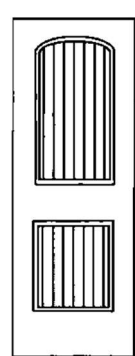

Cashal  
C53\_\_

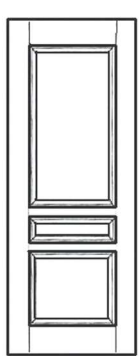

Avalon  
C58\_\_

\*These slabs are too narrow to be bored for standard hardware.

\*\*The 2-panel, square top, grooved panels, and 3-panel doors can be purchased at same list as same size 6-panel slabs with a 2-4 week lead time.

Shaded list price indicates non-stock items. Please allow minimum one week lead time.



## HOLLOW CORE, TEXTURED BIFOLDS

**1 3/8" X 6/7, PRIMED, MOULDED 2 SIDES**

	6-Panel	4-Panel	2-Panel	3-Panel
	Square Top Panel	Eyebrow Top Panel	Eyebrow Top Panel	Square Panel
Item #	C105--	C405--	C505--	C575--
2/0	S	S	S	N/S
2/6	S	S	S	N/S
3/0	S	S	S	N/S
4/0	S	S	S	N/S
5/0	S	S	S	N/S
6/0	S	S	S	N/S

## HOLLOW CORE, SMOOTH BIFOLDS

	6-Panel	4-Panel	2-Panel				
	Square Top Panel	Square Top Panel	Square Top Panel	Eyebrow Top Panel	Arch Top Panel	Arch Top Panel, Grooved Panels	Square Top Panel, Grooved Panels
Item #	C205--	C325--	C465--	C555--	C485--	C525--	C425--
2/0	S	S	S	N/S	S	S	N/S
2/6	S	S	S	N/S	S	S	N/S
3/0	S	S	S	N/S	S	S	N/S
4/0	S	S	S	N/S	S	S	N/S
5/0	S	S	S	N/S	S	S	N/S
6/0	S	S	S	N/S	S	S	N/S

Solid core bifolds are special order items. Call for pricing. Allow minimum one week lead time.  
 Shaded list price indicates non-stock items. Please allow minimum one week lead time.





## MISCELLANEOUS SLABS

1 3/8" x 6/8 PRIMED, SMOOTH

	HOLLOW CORE				SOLID CORE			
	2-Panel	5-Panel		3-Panel	2-panel	5-panel		3-panel
	SANTA FE	ROCKPORT Raised Panel	CONMORE Flat Panel	CRAFTSMEN III	SANTA FE	ROCKPORT Raised Panel	CONMORE Flat Panel	CRAFTSMEN III
	52--	25--	C23--	J27-	53--	26--	C45--	J28-
1/0	N/S	N/A	N/A	N/S	N/S	N/A	N/A	N/S
1/2	N/S	N/A	N/A	N/S	N/S	N/A	N/A	N/S
1/3	N/S	N/A	N/A	N/S	N/S	N/A	N/A	N/S
1/4	N/S	N/A	N/A	N/S	N/S	N/A	N/A	N/S
1/6	N/S	N/A	N/S	S	N/S	N/A	N/S	S
1/8	N/S	N/A	N/S	N/S	N/S	N/A	N/S	N/S
1/10	N/S	N/A	N/S	N/S	N/S	N/A	N/S	N/S
2/0	N/S	N/S	N/S	S	N/S	N/S	N/S	S
2/2	N/S	N/S	N/S	S	N/S	N/S	N/S	N/S
2/4	N/S	N/S	N/S	S	N/S	N/S	N/S	S
2/6	N/S	N/S	N/S	S	N/S	N/S	N/S	S
2/8	N/S	N/S	N/S	S	N/S	N/S	N/S	S
2/10	N/S	N/S	N/S	N/S	N/S	N/S	N/S	N/S
3/0	N/S	N/S	N/S	S	N/S	N/S	N/S	S

## BIFOLDS

SANTA FE  
HOLLOW CORE

CONMORE  
HOLLOW CORE

CRAFTSMEN III  
HOLLOW CORE

1 3/8" X 6/7 PRIMED, SMOOTH

SIZE	525--	SIZE	525--	SIZE	C235--	SIZE	J275--	SIZE	J275--
2/0	N/S	4/0	N/S	3/0	N/S	2/0	S	4/0	S
2/6	N/S	5/0	N/S	4/0	N/S	2/6	S	5/0	S
3/0	N/S	6/0	N/S	5/0	N/S	3/0	S	6/0	S

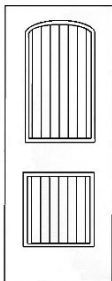

Santa Fe  
52-, 53--

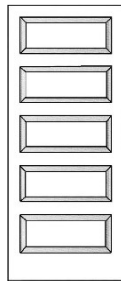

Rockport  
25--, 26--

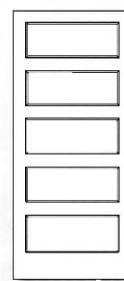

Conmore  
C23--, C45--



Craftsmen III  
J27--, J28--

\*Solid core bifolds require heavy duty bifold track.

Shaded list price indicates non-stock items. Please allow minimum one week lead time.



## 4 OR 6 PANEL SLABS-PINE & RED OAK

1 3/8" X 6/8

SIZE	6-PANEL		4-PANEL
	PINE	RED OAK	PINE
	107--	86--	1074--
1/0	S	N/S	S
1/2	S	N/S	S
1/3	S	N/S	S
1/4	S	N/S	S
1/6	S	S	S
1/8	S	N/S	S
1/10	S	N/S	S
2/0	S	S	S
2/2	S	N/S	S
2/4	S	N/S	S
2/6	S	S	S
2/8	S	S	S
2/10	S	N/S	S
3/0	S	S	S

## 4 OR 6 PANEL BIFOLDS

1 3/8" X 6/7

SIZE	6 PANEL		4 PANEL
	PINE	RED OAK	PINE
	745--	865--	7045--
2/0	S	S	N/S
2/6	S	S	N/S
3/0	S	S	N/S

Shaded list price indicates non-stock items. Please allow three weeks lead time.

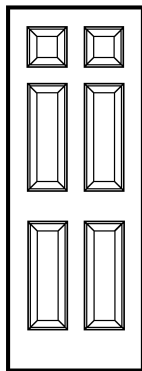

6-Panel  
107 --

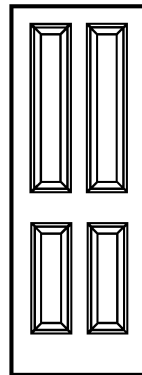

4-Panel  
1074 --



**Interior Doors**  
 Section 3 – Page 11  
 List Price  
 Effective Date 2/6/17  
 Revised Date 1/17/17

## FRENCH DOOR SLABS-PINE & RED OAK

1 3/8" x 6/8

SIZE	15-LITE WOOD DIVIDED		1-LITE	9-LITE (PRAIRIE)
		PINE	RED OAK	PINE
	# LITES	77--	87--	76- 779-
1/0	5-LITE	Call for pricing	Call for pricing	Call for pricing
1/2	5-LITE	Call for pricing	Call for pricing	Call for pricing
1/3	5-LITE	N/S	Call for pricing	Call for pricing
1/4	5-LITE	N/S	Call for pricing	Call for pricing
1/6	5-LITE	S	N/S	Call for pricing
1/8	5-LITE	N/S	N/S	Call for pricing
1/10	10-LITE	N/S	Call for pricing	Call for pricing
2/0	10-LITE	S	S	S
2/2	10-LITE	N/S	N/S	Call for pricing
2/4	15-LITE	S	N/S	Call for pricing
2/6	15-LITE	S	S	S
2/8	15-LITE	S	S	S
2/10	15-LITE	N/S	N/S	Call for pricing
3/0	15-LITE	S	S	S

All 15-lite slabs are available as 10-lite via special order. Allow 4-6 week lead time

Shaded list price indicates non-stock items. Please allow minimum 4-6 weeks lead time.

## PRIMED FRENCH SLABS

SIZE	ITEM #	DESCRIPTION	PRICE
2/0	7720PR	15 LITE, 1 3/8" X 6/8	S
2/6	7726PR	15 LITE, 1 3/8" X 6/8	S
3/0	7730PR	15 LITE, 1 3/8" X 6/8	S



## FLUSH SLABS-BIRCH & RED OAK

1 3/8" X 6/8

SIZE	HOLLOW CORE		SOLID CORE	
	BIRCH	RED OAK	BIRCH	RED OAK
	60- -	80- -	64- -	84- -
1/0	N/S	N/S	N/S	N/S
1/2	N/S	N/S	N/S	N/S
1/3	N/S	N/S	N/S	N/S
1/4	N/S	N/S	N/S	N/S
1/6	S	N/S	S	N/S
1/8	N/S	N/S	N/S	N/S
1/10	N/S	N/S	N/S	N/S
2/0	S	N/S	S	N/S
2/2	N/S	N/S	N/S	N/S
2/4	S	N/S	S	N/S
2/6	S	N/S	S	N/S
2/8	S	N/S	S	N/S
2/10	N/S	N/S	N/S	N/S
3/0	S	N/S	S	N/S

## FLUSH, HOLLOW CORE BIFOLDS

1 3/8" X 6/7

SIZE	BIRCH	RED OAK
	605--	805--
2/0	S	N/S
2/6	S	N/S
3/0	S	N/S
4/0	S	N/S
5/0	S	N/S
6/0	S	N/S

Shaded list price indicates non-stock items. Please allow two weeks lead time.

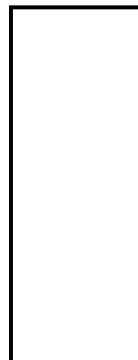

Flush Door



**Interior Doors**  
 Section 3 – Page 13  
 List Price  
 Effective Date 2/6/17  
 Revised Date 1/24/17

## LOUVER/LOUVER SLABS

PINE			PRIMED		
SIZE	ITEM #	PRICE	ITEM #	PRICE	
1/6	7816	N/S	N/A	N/A	
1/8	7818	N/S	N/A	N/A	
2/0	7820	S	7820PR	S	
2/4	7824	S	N/A	N/A	
2/6	7826	S	7826PR	S	
2/8	7828	S	N/A	N/A	
3/0	7830	S	7830PR	S	

Shaded list price indicates non-stock items. Please allow minimum one week lead time.

### SANTA ROSA SLABS-KNOTTY PINE

SIZE	ITEM # - PANEL #21	ITEM # - PANEL #22	PRICE
1/6	71116	71216	N/S
2/0	71120	71220	N/S
2/4	71124	71224	N/S
2/6	71126	71226	N/S
2/8	71128	71228	N/S
3/0	71130	71230	N/S

Santa Rosa shaded list prices are non-stock items. Please allow minimum four week lead time.

## BIFOLDS

SIZE	1 1/8" X 6/7	1" X 6/8	1 3/8" X 6/7
	LOUVER/LOUVER	LOUVER/LOUVER PRIMED	SANTA ROSA
	785--	785--PR	7115--, 7125--
2/0	S	S	N/S
2/6	S	S	N/S
3/0	S	S	N/S
4/0	S	S	N/S
5/0	S	S	N/S
6/0	S	S	N/S

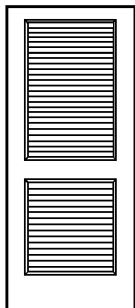

Louwer/Louwer  
78--

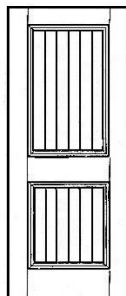

Santa Rosa Panel #21  
711--

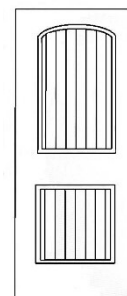

Santa Rosa Panel #22  
712--



## MIRROR DOOR UNITS

6/8 HEIGHT

### BYPASS UNITS

ITEM #	SIZE	DESCRIPTION	PRICE
MD40	4/0	2-2/0 WHITE FRAME, SLABS W/HARDWARE	N/S
MD50	5/0	2-2/6 WHITE FRAME, SLABS W/HARDWARE	N/S
MD60	6/0	2-3/0 WHITE FRAME, SLABS W/HARDWARE	N/S

### BIFOLD UNITS

ITEM #	SIZE	DESCRIPTION	PRICE
LMB20	2/0	SINGLE FRAMELESS BIFOLD UNIT W/ HARDWARE	N/S
LMB26	2/6	SINGLE FRAMELESS BIFOLD UNIT W/ HARDWARE	N/S
LMB30	3/0	SINGLE FRAMELESS BIFOLD UNIT W/ HARDWARE	N/S

## 4 5/8" BIFOLD JAMB SETS

	FINGER-JOINT PRIMED	PINE	POPLAR	OAK
<b>WITH 3/4" COVE, NO CASING-KNOCKED DOWN</b>				
2/0-3/0	S	S	S	S
4/0-6/0	S	S	S	S
<b>WITH 3/4" COVE &amp; 2 1/4" CASING FOR BOTH SIDES</b>				
2/0-3/0	S	S	S	S
4/0-6/0	S	S	S	S
<b>WITH 3/4" COVE &amp; 3 1/4" CASING FOR BOTH SIDES</b>				
2/0-3/0	S	S	S	S
4/0-6/0	S	S	S	S

## MISCELLANEOUS DOOR PARTS

ITEM #	DESCRIPTION	SIZE	PRICE
SHIM	Shim Shakes		S
S575A	Door Sill, Aluminum In-Swing	5 3/4" x 3/0	S
S575B	Door Sill, Bronze In-Swing	5 3/4" x 3/0	S
S725A	Door Sill, Aluminum In-Swing	7 1/4" x 3/0	S
S725B	Door Sill, Bronze In-Swing	7 1/4" x 3/0	S
MI324	Door Catches – Magnetic	1 3/4" x 9/16"	S
CS30	Compression Strip - Brown	3/0	S
CS68	Compression Strip - Brown	6/8	S
CS80	Compression Strip – Brown	8/0	N/S
CS70BR	Compression Strip - Brown	7/0	N/S
CS70W	Compression Strip – White	7/0	N/S
DB30	Finned Door Bottom	3/0	S
8110	Bolt –Surface Brass	6"	S



## WOOD LITE KITS w/SAFETY GLASS

### FOR SOLID CORE BIRCH DOORS

ITEM #	SIZE	KIT	INSTALLED
LK1010	1 3/8" x 10" x 10"	Call for pricing.	Call for pricing.
LK630	1 3/8" x 6" x 30"	Call for pricing.	Call for pricing.
LK424	1 3/8" x 4" x 24"	Call for pricing.	Call for pricing.
LK2024	1 3/8" x 20" x 24"	Call for pricing.	Call for pricing.
LK1616	1 3/8" x 16" x 16"	Call for pricing.	Call for pricing.
LK2036	1 3/8" x 20" x 36"	Call for pricing.	Call for pricing.
LK2424	1 3/8" x 24" x 24"	Call for pricing.	Call for pricing.
LK2430	1 3/8" x 24" x 30"	Call for pricing.	Call for pricing.
LK2436	1 3/8" x 24" x 36"	Call for pricing.	Call for pricing.
LK2064	1 3/8" x 20" x 64"	Call for pricing.	Call for pricing.
LK2264	1 3/8" x 22" x 64"	Call for pricing.	Call for pricing.
LK4244	1 3/4" x 4" x 24"	Call for pricing.	Call for pricing.
LK10104	1 3/4" x 10" x 10"	Call for pricing.	Call for pricing.
LK20364	1 3/4" x 20" x 36"	Call for pricing.	Call for pricing.
LK24304	1 3/4" x 24" x 30"	Call for pricing.	Call for pricing.
LK24364	1 3/4" x 24" x 36"	Call for pricing.	Call for pricing.
LK20644	1 3/4" x 20" x 64"	Call for pricing.	Call for pricing.

Installed lite kit is 6" from top of door and centered from left to right. Different location must be specified.

Other sizes are available. Please contact your sales representative for availability and pricing.

Allow two weeks lead time for installation of lite kits.

## BASSWOOD LOUVERS FOR FLUSH DOORS

SIZE	LOUVER	INSTALLED
12" X 12"	Call for pricing.	Call for pricing.
20" X 12"	Call for pricing.	Call for pricing.
24" X 24"	Call for pricing.	Call for pricing.

Louvers are for either 1 3/8" or 1 3/4" flush Birch door slabs.

Allow one week lead time for installation of louvers.



## INTERIOR TRANSOM UNIT WITH WOOD GRILLS & CLIP SYSTEM

ITEM #	1 LITE		3, 5, OR 7 LITE		
	SIZE	PINE (66)	RED OAK (99)	PINE (66)	RED OAK (99)
<b>3/0</b>					
TG3610--	10"	N/S	N/S	N/S	N/S
TG3612--	12"	N/S	N/S	N/S	N/S
TG3614--	14"	N/S	N/S	N/S	N/S
TG3616--	16"	N/S	N/S	N/S	N/S
<b>4/0</b>					
TG4810--	10"	N/S	N/S	N/S	N/S
TG4812--	12"	N/S	N/S	N/S	N/S
TG4814--	14"	N/S	N/S	N/S	N/S
TG4816--	16"	N/S	N/S	N/S	N/S
<b>5/0</b>					
TG6010--	10"	N/S	N/S	N/S	N/S
TG6012--	12"	N/S	N/S	N/S	N/S
TG6014--	14"	N/S	N/S	N/S	N/S
TG6016--	16"	N/S	N/S	N/S	N/S
<b>6/0</b>					
TG7210--	10"	N/S	N/S	N/S	N/S
TG7212--	12"	N/S	N/S	N/S	N/S
TG7214--	14"	N/S	N/S	N/S	N/S
TG7216--	16"	N/S	N/S	N/S	N/S

Direct set transom unit with wood bars and clip system, shipped loose, laminated glass, HH936 door stop on both sides, 4 9/16" pine jambs, and HH984 mullion - shipped loose.

Transoms shipped assembled, but not attached to door unit.

These transom units are made per order. Allow minimum two week lead time.





## INTERIOR TRANSOM UNIT WITH TRUE DIVIDED LIGHTS

### SASH ONLY

ITEM #	SIZE	DESCRIPTION	PINE (66)	RED OAK (99)
TS3210	1 3/8" x 32" x 10"	3 LITES	N/S	N/S
TS3212	1 3/8" x 32" x 12"	3 LITES	S	N/S
TS3214	1 3/8" x 32" x 14"	3 LITES	N/S	N/S
TS3610	1 3/8" x 36" x 10"	3 LITES	N/S	N/S
TS3612	1 3/8" x 36" x 12"	3 LITES	S	N/S
TS3614	1 3/8" x 36" x 14"	3 LITES	N/S	N/S
TS4810	1 3/8" x 48 1/2" x 10"	4 LITES	N/S	N/S
TS4812	1 3/8" x 48 1/2" x 12"	4 LITES	S	N/S
TS4814	1 3/8" x 48 1/2" x 14"	4 LITES	N/S	N/S
TS6010	1 3/8" x 60 1/2" x 10"	7 LITES	N/S	N/S
TS6012	1 3/8" x 60 1/2" x 12"	7 LITES	S	N/S
TS6014	1 3/8" x 60 1/2" x 14"	7 LITES	N/S	N/S
TS7210	1 3/8" x 72 1/2" x 10"	7 LITES	N/S	N/S
TS7212	1 3/8" x 72 1/2" x 12"	7 LITES	S	N/S
TS7214	1 3/8" x 72 1/2" x 14"	7 LITES	N/S	N/S

## ADDERS FOR COMPLETE TRANSOM UNIT

	OPTION 1 (TSS)		OPTION 2 (CTS)	
	<i>Sash aligned with door</i>		<i>Sash centered in jamb</i>	
	HH936 Colonial door stop opposite door side HH108 (1/2" quarter round) on door side		HH936 Colonial door stop both sides	
<b>PINE</b>				
	<b>4 5/8" JAMBS</b>	<b>6 5/8" JAMBS</b>	<b>4 5/8" JAMBS</b>	<b>6 5/8" JAMBS</b>
<b>UP TO 3/0</b>	N/S	N/S	N/S	N/S
<b>4/0</b>	N/S	N/S	N/S	N/S
<b>5/0</b>	N/S	N/S	N/S	N/S
<b>6/0</b>	N/S	N/S	N/S	N/S
<b>RED OAK</b>				
	<b>4 5/8" JAMBS</b>	<b>6 5/8" JAMBS</b>	<b>4 5/8" JAMBS</b>	<b>6 5/8" JAMBS</b>
<b>UP TO 3/0</b>	N/S	N/S	N/S	N/S
<b>4/0</b>	N/S	N/S	N/S	N/S
<b>5/0</b>	N/S	N/S	N/S	N/S
<b>6/0</b>	N/S	N/S	N/S	N/S

Indicate Option choice (#1 or #2) when ordering.

Add your option choice adder to the sash price to determine your complete transom unit price.

Cross rails are 1 7/8" thick and the sides are wide stiles at 4 1/2".

Transoms are shipped assembled, but not attached to the door unit.

Transom sashes are available with center glass to match door stiles. Please allow 4-6 weeks lead time.

Shaded items are non-stock. Allow 4-6 weeks lead time.